

## *Le luminaire*

"Un service dans un monde évolutif"

**Adrien CAPAINE**

*Ingénieur réseaux*

**Oya Light**

# Agenda

*I. IoT*

*II. Société*

*III. Perspectives*

# Gartner's Hype Cycle ( July 2014 )



Plateau will be reached in:

○ less than 2 years

● 2 to 5 years

● 5 to 10 years

▲ more than 10 years

○ obsolete

⊗ before plateau

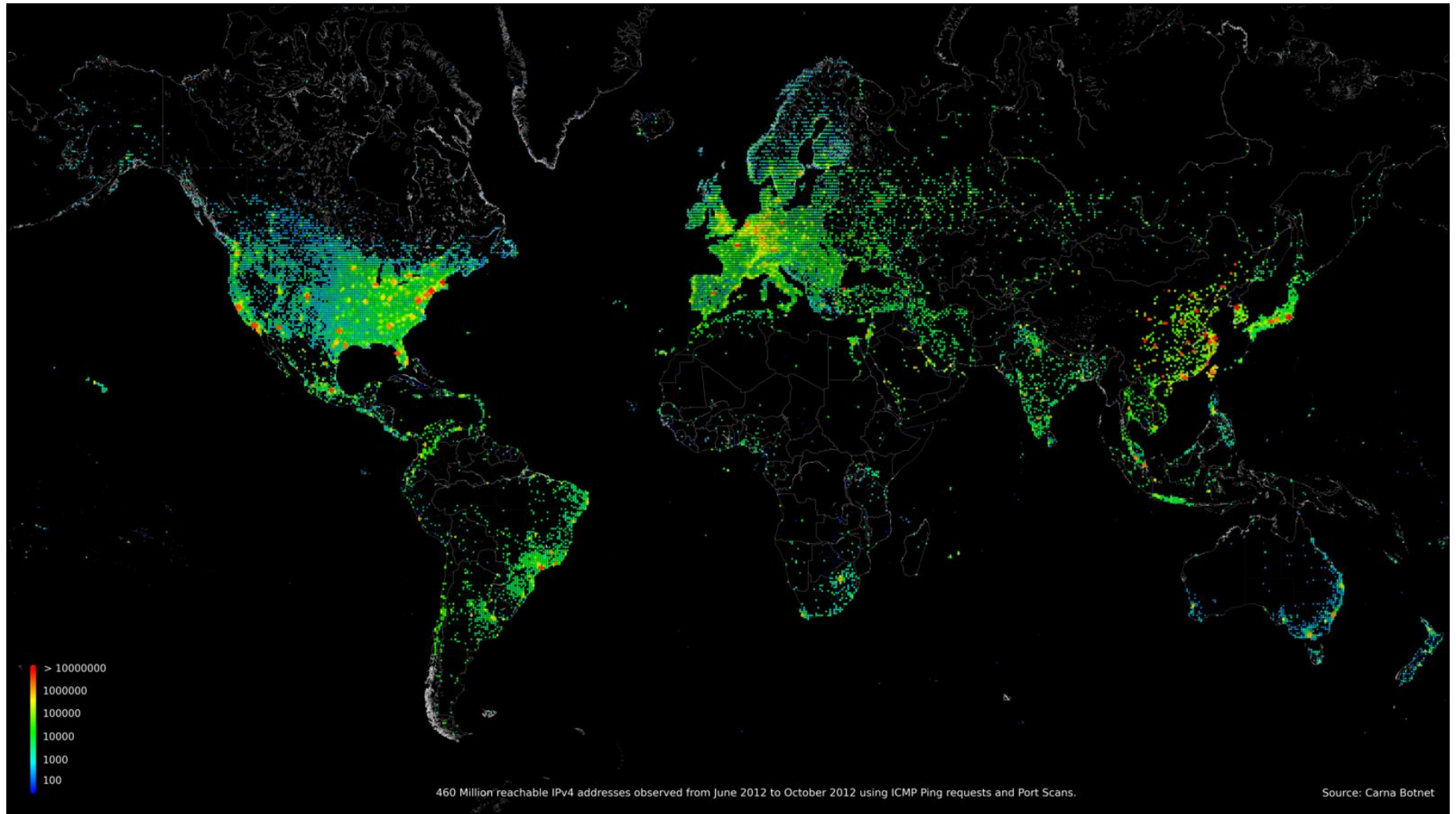



$\phi$  : 1000 – 14000 lm  
 $\eta$  : ~ 100 lm/W

Prestations sur mesure  
Etudes photométriques

MQTT  
Li-Fi  
EnOcean  
6LoWPAN

  
ECLAIRAGE

  
EFFICACITÉ  
ÉNERGÉTIQUE

  
SERVICES

NF EN 12464





# Use Cases

*I. G.L.I.E.*

*II. PoC*

# Projet GLIE

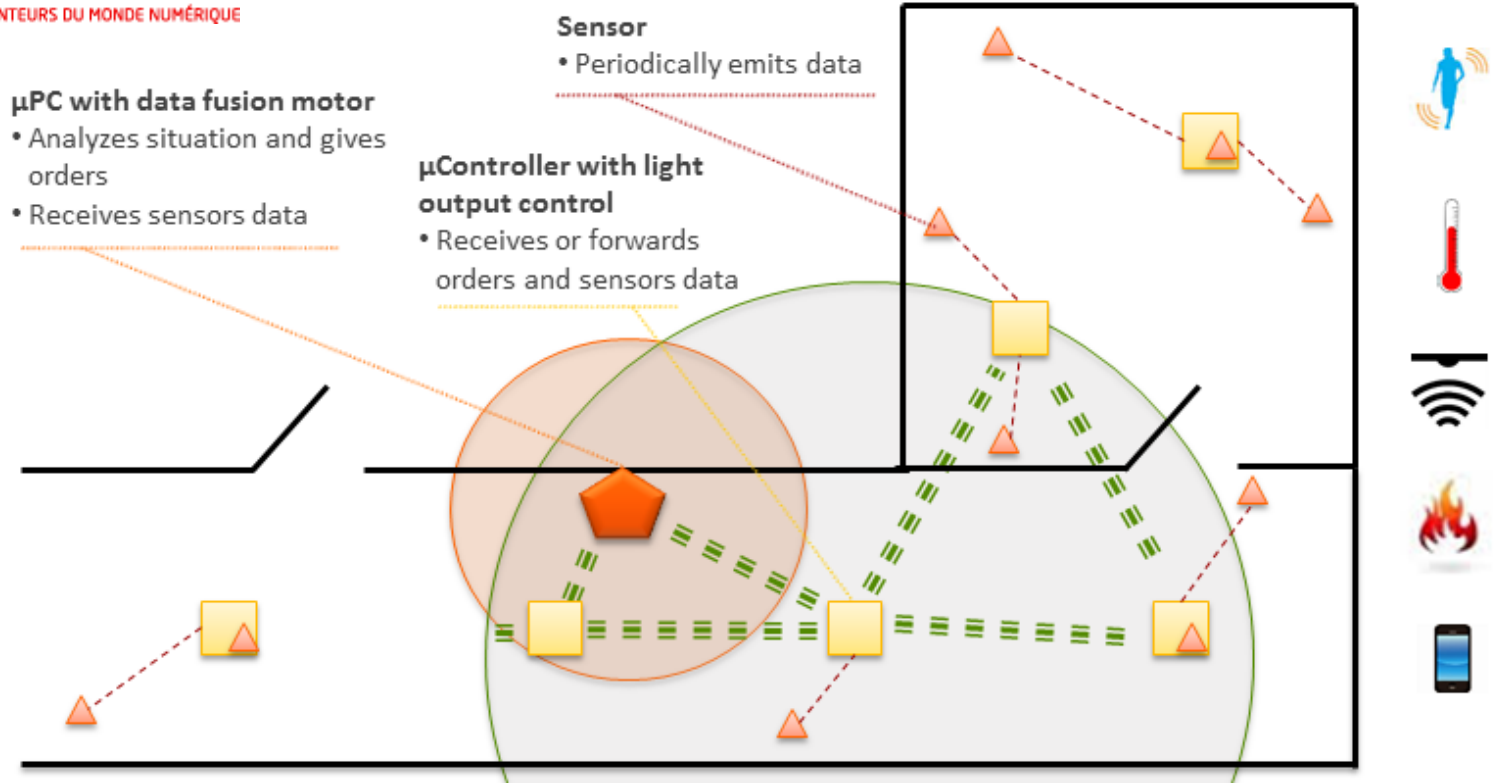

 Sensor    
  Smart LED    
  Data fusion engine    
  6LoWPAN transmissions



**Proof of concept**  
**Dalle LED en liaison Li-Fi**  
**bidirectionnelle**

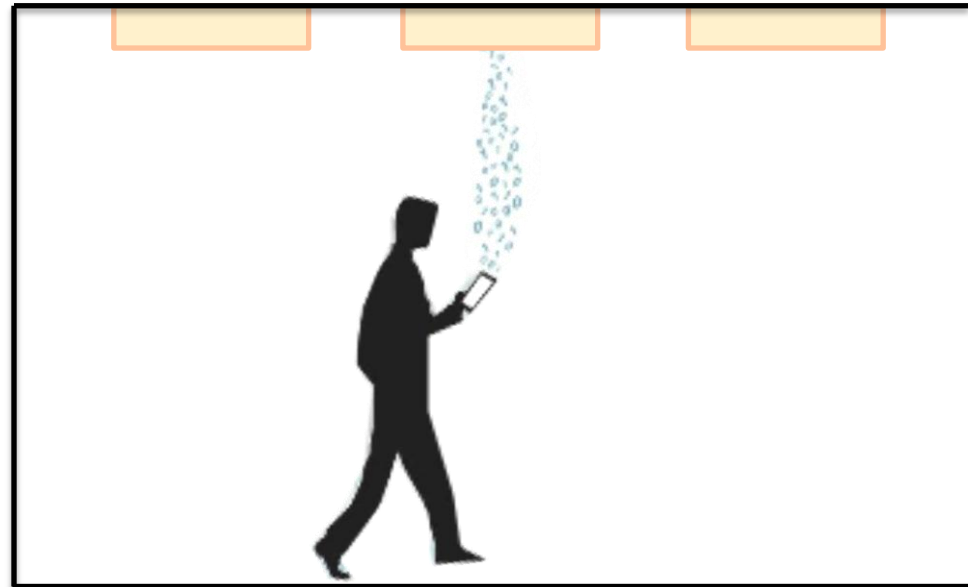
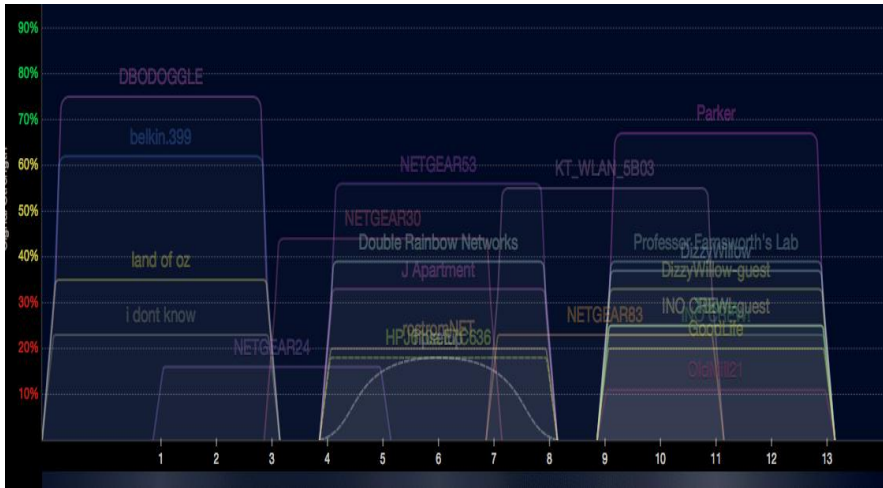





# Perspectives

*I. Impact de la lumière sur l'Homme*

*II. uPoE*



# I. Impact de la lumière sur l'Homme

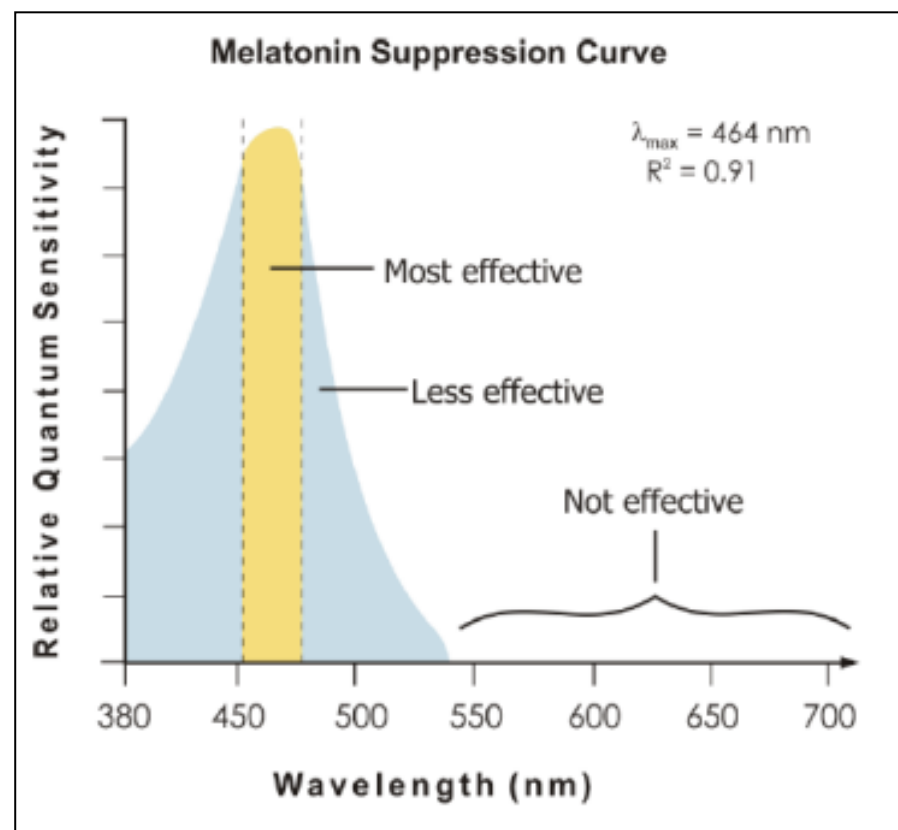
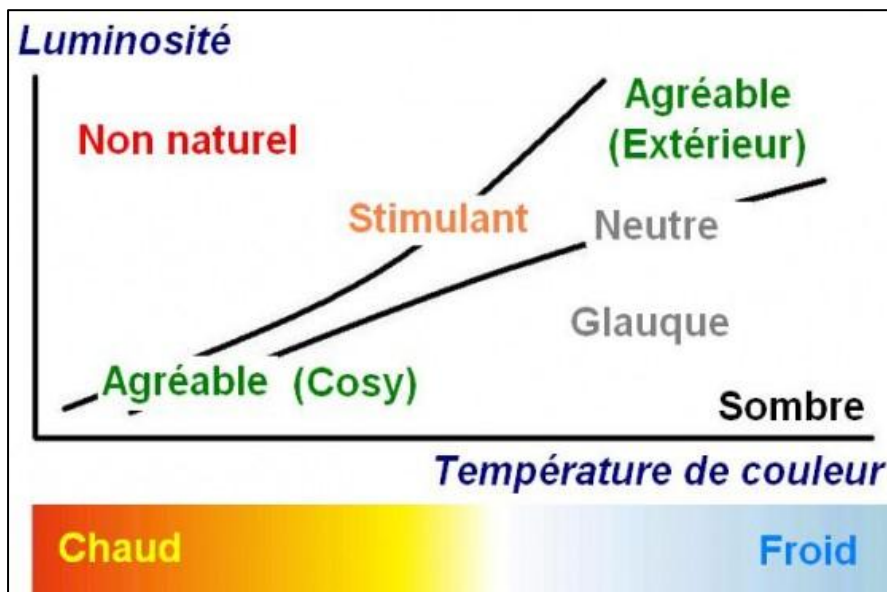

## II. uPoE



Today's Workspace

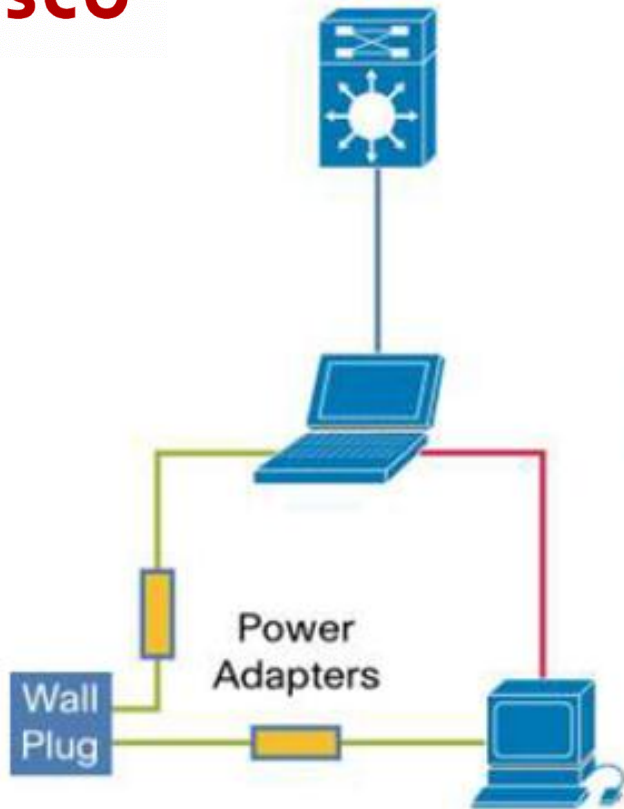

Next Generation Workspace

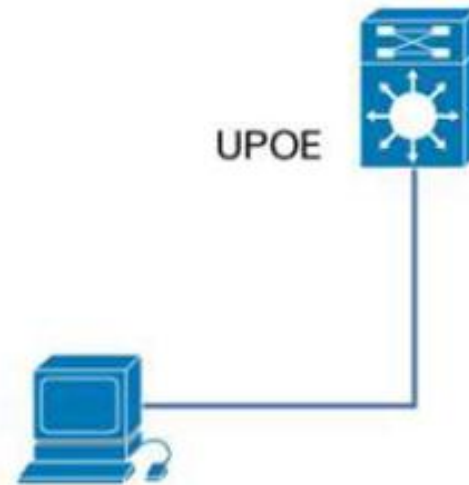

**60 W sur le end-point !**



## *Le luminaire*

"Un service dans un monde évolutif"

**Merci de votre attention**

**Adrien CAPAINE**

*Ingénieur réseaux*

**Oya Light**